



Designers' Choice

# AUDIO JACKS & "F" CONNECTORS

## SURFACE MOUNT STEREO JACKS

- Mates with 2.5mm and 3.5mm plugs
- Designed for reliable interface with audio equipment including computer speakers, headphones, sound cards, cell phones, etc.
- Models available for mono and stereo applications
- Low profile, surface mount design

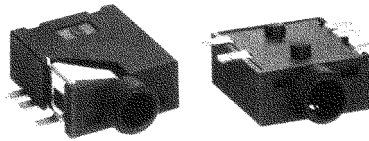

### SPECIFICATIONS

**Housing:** Polyamide, Rated UL 94V-0  
**Ground Terminal:** .012 Brass, Gold Flash ①  
**Spring Contacts:** .008 Phosphor Bronze, Gold Flash ② ⑤  
**Shunt Terminals:** .012 Brass, Gold flash ③ ④

### FOR 2.5mm PLUGS

Supplied on Tape and Reel

### FOR 3.5mm PLUGS

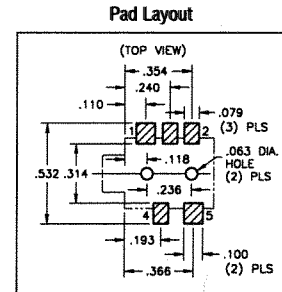
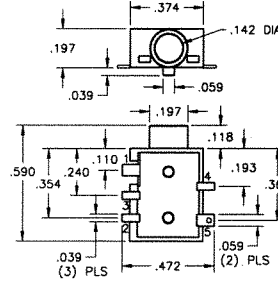
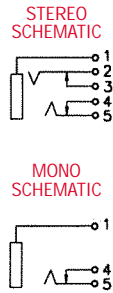
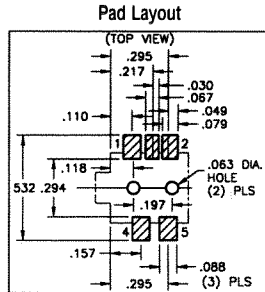
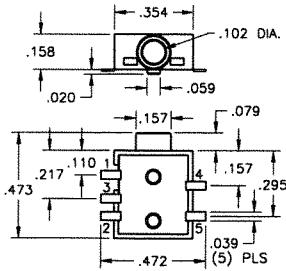

CAT. NO. 980TR (Stereo) Tape Spec's: 24mm wide; 16mm pitch  
 CAT. NO. 982TR (Mono) Reel Spec's: 15 inch reel (1,000 pieces per reel)

CAT. NO. 981TR (Stereo) Tape Spec's: 24mm wide; 16mm pitch  
 CAT. NO. 983TR (Mono) Reel Spec's: 15 inch reel (800 pieces per reel)

## COLOR KEYED — PC PHONO JACKS

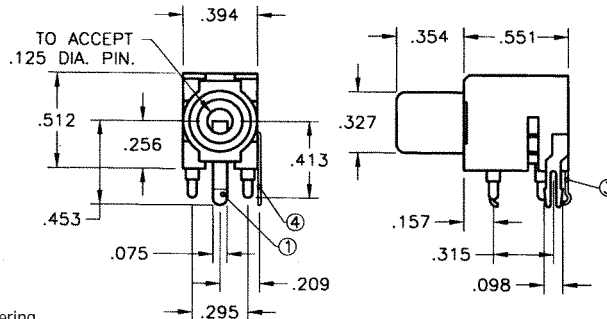
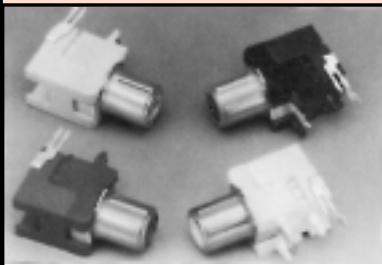

- Mates with .125 diameter pins
- Features a normally closed circuit
- Various colors for circuit identification
- Snap-fit mounting for positive retention during wave soldering

CAT. NO.	COLOR
970	WHITE
971	RED
972	BLACK
973	YELLOW

### SPECIFICATIONS

**Housing:** PBT  
**Ground Terminal:** .020 Brass, Nickel Plate ①  
**Spring Contact:** .012 Phosphor Bronze, Silver Plate ③  
**Shunt Terminal:** .016 Brass, Silver Plate ④

### Mounting Detail

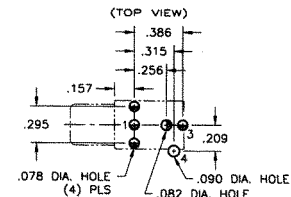

## "F" FEMALE CONNECTORS

### SNAP-FIT PC MOUNT

- Low profile
- Snap-fit mounting for positive retention during wave soldering
- Rugged, stable construction facilitates reliable mating
- High reliability, manufactured using Nickel Plated Brass bodies and Tin Plated Phosphor Bronze contacts
- Supplied with washer and nut

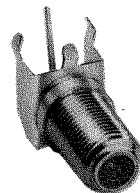
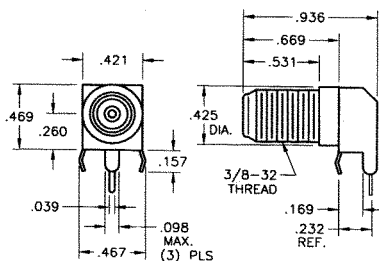

### Mounting Detail

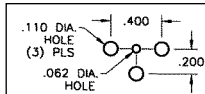

CAT. NO. 911

### PANEL MOUNT

- Anti-rotation design
- Rugged construction facilitates reliable mating
- High reliability, manufactured using Nickel Plated Brass bodies and Tin Plated Phosphor Bronze contacts
- Supplied with washer and nut

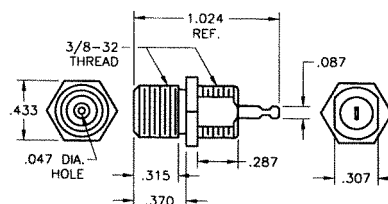

### Mounting Detail

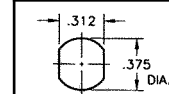

CAT. NO. 912